

User Manual

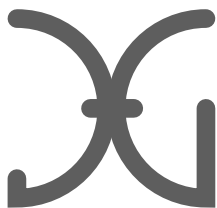

Touch Control
Ceramic Hob

JG3001P





[01] x 1



[02] x 4

Note: Items 2 and 3 are pre-fitted in the factory
there is no assembly of these components required.

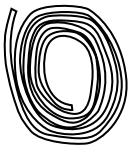

[04] x 1

[03] x 4



Touch Control Ceramic Hob

JG3001P

Installation
Installation



21

Let's get started ...



Getting started...

05

Safety

06

Before you start

09



In more detail...

10

Product functions

11

Operation

12

Care and maintenance

15

Troubleshooting

17

Recycling and disposal

18

Technical and legal information

19



Appendix

Installation

21



Getting Started ...

Safety	06
Before you start	09



These instructions are for your safety. Please read through them thoroughly prior to installation and retain them for future reference.



- All installation work must be carried out by a competent person or qualified electrician.
- This appliance must be installed correctly by a suitably qualified person, strictly following the manufacturer's instructions.

- This appliance complies with all current European safety legislation, however, the Manufacturer must emphasise that this compliance does not prevent the surfaces of the appliance from heating up during use and remaining hot during its operation.
- Accessible parts may become hot during use. Young children should be kept away. Care should be taken to avoid touching the appliance (e.g hob, cooker).
- The Manufacturer highly recommends that this appliance be kept out of the reach of babies and small children.
- Children should be supervised to ensure that they do not play with the appliance.
- Means for isolating the appliance must be incorporated in the fixed wiring in accordance with the current wiring regulations. An all-pole disconnection the current wiring regulations. An all-pole disconnection switch having a contact separation of at least 3 mm in all poles should be connected in fixed wiring.
- Damaged power cables should be replaced by a ompetent person or qualified electrician.

- Make sure that the power cord is not caught under or in the appliance and avoid damage to the power cable.
- Do not allow the electric cables to touch the hot parts of the appliance.
- Do not install the appliance outdoors in a damp place or in an area which may be prone to water leaks such as under or near a sink unit. In the event of a water leak allow the machine to dry naturally.
- Please dispose of the packing material carefully.
- Do not use flammable sprays in close vicinity to the appliance.
- We also recommend that great care be taken during use and cleaning. Read the cleaning and maintenance sections for this appliance carefully.
- A steam cleaner is not to be used.
- The appliance is not intended to be operated by means of external timer or separated remote-control system.
- The appliance is for domestic use only.
- When a cooking zone has been on for a long time, the surface remains hot for some time afterwards so do not touch the ceramic surface.
- Do not store detergents or flammable materials beneath the hob.
- Do not leave hot oils or fats unattended as they may catch light.

- ✓ The Manufacturer declines all liability for personal or material damage as a result of misuse or incorrect installation of this appliance.
- ✓ This appliance can be used by children aged from 8 years and above and persons with reduced physical, sensory or mental capabilities or lack of experience and knowledge if they have been given supervision or instruction concerning use of the appliance in a safe way and understand the hazards involved. Children shall not play with the appliance. Cleaning and user maintenance shall not be made by children without supervision.
- ✓ **WARNING:** The appliance and its accessible parts become hot during use. Care should be taken to avoid touching heating elements. Children less than 8 years of age shall be kept away unless continuously supervised.
- ✓ **WARNING:** Unattended cooking on a hob with fat or oil can be dangerous and may result in fire.
NEVER try to extinguish a fire with water, but switch off the appliance and then cover flame e.g. with a lid or a fire blanket.
- ✓ **WARNING:** Danger of fire: do not store items on the cooking surfaces.
- ✓ **WARNING:** If the surface is cracked, switch off the appliance to avoid the possibility of electric shock.
- ✓ **WARNING:** Use only hob guards designed by the manufacturer of the cooking appliance or indicated by the manufacturer of the appliance in the instructions for use as suitable or hob guards incorporated in the appliance. The use of inappropriate guards can cause accidents.

This appliance is designed for domestic use only. The manufacturer shall not in any way be held responsible for whatever injuries or damages are caused by incorrect installation or by unsuitable or incorrect use!

Before you start

- To avoid the risks that are always present when you use an electrical appliance it is important that this appliance is installed correctly and that you read the safety instructions carefully to avoid misuse and hazards. Please keep this instruction booklet for future reference and pass it on to any future owners. After unpacking the appliance please check that it is not damaged. If in doubt, do not use the appliance, and contact the after sales service department.
- Check the package and make sure you have all of the parts listed.
- Decide on the appropriate location for your product.
- If this product contains glass please take care when fitting or handling to prevent personal injury or damage to the product.
- The specifications plate is located on the base of this appliance. This plate displays all the necessary identification information for ordering replacement parts.
- If you sell the appliance, give it away, or leave it behind when you move house, make sure you also pass on this manual so that the new owner can become familiar with the appliance and its safety warnings.

Tools required

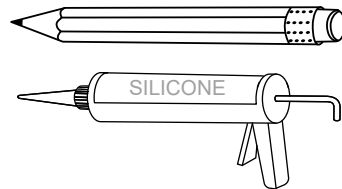
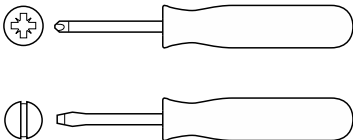

In more detail...



Product functions	11
Operation	12
Care and maintenance	15
Troubleshooting	17
Recycling and disposal	18
Technical and legal information	19

Product functions

- > The ceramic hob caters for all kind of cooking, with its radiant heat cooking zones and its electronic touch controls and multi-functions, making it the ideal choice for the modern family.
- > The ceramic hob is extremely user-friendly, durable and safe.

Special functions

Protection from over-heating

- > A sensor monitors the temperature in the cooking zones. When the temperature exceeds a safe level, the cooking zone is automatically switched off.

Residual heat indicator

- > When the hob has been operating for some time, there will be some residual heat. The letter "H" appears to warn you that it is too hot to touch the surface.

Timer function

- > You can set the timer of each cooking zone for 1-120 minutes.

Auto shutdown

- > Another safety feature of the ceramic hob is auto shutdown. This occurs whenever you forget to switch off a cooking zone. The heating zone will shutdown automatically after 120 minutes.

Protection against unintended operation.

- > If the electronic control detects a button being held down for approx 10 seconds it will switches off automatically. The control sends out an audible error signal to warn the sensors have of an object. The display will indicate an error code E6.







Operation



The following shows how to reduce total environmental impact (e.g. energy use) of the cooking process).

1. Use suitable size of pan for cooking.
2. Cover the pan with lid if possible during cooking.
3. Choose pan which has better retaining heat capacity.
4. If possible, defrost frozen food in a way which does not need any power consumption.
5. It takes less time to cook food which has large surface area to volume ratio.

Operation



Reference	Description
A  	Zone position
B 	Power regulating key (reduce)
C 	Power regulating key (increase)
D 	ON / OFF
E 	Child lock key
F 	Timer key

Heating Zone	Total Power (220-240V~ 50/60Hz)
	1800 W
	1200 W
Total Power	3000 W(230V~)

Operation

Touch sensitive keys.

All operations can be performed using touch sensitive keys (capacitive sensors) located on the front of the ceramic glass (control panel). Each key has a corresponding display. All actions are confirmed by an audible beep.

Preparation before use

>When the power is switched on, the buzzer will sound once and all the indicators will switch on for one second and then switch off. Place the pan in the centre of the cooking zone.

Operating instructions









Caution

- When the ON/OFF key (D) is pressed, the ceramic hob returns to off mode if no other operation is carried out within 20 seconds.

Heating zone operation

When the ON/OFF key " " is pressed, all the indicators show "-."

1. Select the cooking zone you wish to use by pressing the " " or " " key (A). The symbol selected will be displayed " " or " ".
2. Select the power level by pressing the "+" key (C) " " or "-" key (B) " ".
3. The power level will start at 0. Pressing the "+" will count up the power levels from 0 to 9 (max power) in numerical order. Pressing the "-" key will take the power straight from 0 to 9. Pressing the "-" key again will reduce the power level.
4. To adjust the power level at a later stage select the desired cooking zone first.
5. Select the cooking zone, press "-" to reduce the power level to 0, the cooking zone will be turned off.

Safety mode (Child lock)

You can lock the controls to prevent unintended use (for example children accidentally turning the cooking zones on).

When the controls are locked, all the controls except the OFF control are disabled.

To lock the controls

Touch the key (E)  for 3 seconds. The timer indicator will show "Loc"

To unlock the controls

1. Make sure the hob is turned on.
2. Touch the key E  for 3 seconds
3. You can now start using your hob.



When the hob is in the lock mode, all the controls are disabled except OFF, you can always turn the hob off with the OFF control in an emergency, but you shall unlock the hob first in the next operation.

Using the timer

You can set the timer to turn one cooking zone off after the set time is up.

You can set the timer for up to 120 minutes.

1. Select the relevant cooking zone which is working by touching the zone select key (A).
2. Press the Timer key (F) , the timing indicator flashes, and you can set the timer at this point.
3. Press the "+" and "-" keys, you can set the timer from 1 to 120 minutes.
4. When the time is set, it will begin to count down immediately. The display will show the remaining time and the timer indicator flash for 5 seconds.
5. When cooking timer expires, the corresponding cooking zone will be Switch off automatically and buzzer 3 times.
6. If 2 burners are at work, when one burner has the timing, it will always display the burner working level and time, if 2 burners both have timing, but just only display burner working level and time for the last action.

**Warning**

Always switch off the electricity supply before performing maintenance work. In the event of a fault, contact customer services.

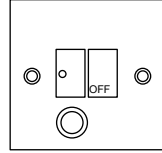

Care and maintenance

Care



Damaged power cables should be replaced by a competent person or qualified electrician.



For domestic use only.



Never place an empty pan on the hob as this will cause the over heat protection, then the appliance will switches off automatically.



When a cooking zone has been on for a long time, the surface remains hot for some time afterwards so do not touch the ceramic surface.



For sealed foods, please do not heat them before opening removing the lid so as to avoid any dangers of explosion due to heating expansion.



If the surface of the hob is cracked, disconnect the hob from power the supply to avoid any possibility of electric shocks.



Do not place rough or uneven pans on the hob, as they could damage the ceramic surface.



Avoid banging pots and pans down on the hob.
The ceramic surface is tough but not unbreakable.



Do not put detergents or flammable materials beneath the hob.

Care and maintenance

Appliance cleanliness



Caution

- Avoid rubbing with any abrasive or with the base of the pans, etc, as this will wear the markings on the top of the ceramic hob over time.
- Clean the ceramic hob on a regular basis to prevent the build up of food residue.

>The appliance should be cleaned after use.

>The surface of the ceramic hob may be easily cleaned in the following way:

Type of dirt	Cleaning method	Cleaning materials
Limescale	Apply white vinegar to the surface, then wipe it dry with soft cloth	Special ceramic cleaner
Burnt-on stains	Clean with damp cloth and dry it with a soft cloth	Special ceramic cleaner
Light stains	Clean with damp cloth and dry it with a soft cloth	Cleaning sponge
Melted plastics	Use a scraper suitable for ceramic glass to remove residue	Special ceramic cleaner

Troubleshooting

If an problem occurs, the induction hob will enter the protective state automatically and display corresponding protective codes:

Error Message	Possible Cause	What to do
E6	Press any key more than 10 seconds	Release the key and then the appliance reset automatically
H1	The temperature inside the appliance is too high.	Stop and cooling the appliance

Before calling the customer services, please check that the appliance is correctly connected, any of the following cases are not covered by the guarantee

- > Damage caused by improper use, storage or maintenance
- > Damage caused by unauthorised disassembly and repair.
- > Damage caused by misuse.
- > Using the ceramic hob for commercial purposes.

Recycling and Disposal

Environmental Protection

Waste electrical products should not be disposed of with household waste. Please recycle where facilities exist. Check with your Local Authority or retailer for recycling advice.



The symbol on the product or its packaging indicates that this product cannot be treated as normal household waste. This product must be handed over to an electric and electronic equipment collection point for recycling.

On ensuring that this product is disposed of correctly, you will help to avoid possible negative consequences for the environment and public health, which could occur if this product is not handled correctly. To receive more detailed information about recycling this product, contact your local government, domestic waste disposal services or the outlet where the product was bought.

Information for dismantling

Do not dismantle the appliance in a way which is not shown in the user manual. The appliance could not be dismantled by user. At the end of life, the appliance should not be disposed of with household waste. Check with you Local Authority or retainer for recycling advice.

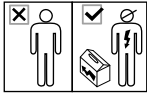

All installation work must be carried out by a competent person or qualified electrician. Before connecting the mains supply ensure that the mains voltage corresponds to the voltage on the rating plate inside the cooker hood.

Warning: THIS APPLIANCE MUST BE EARTHED .

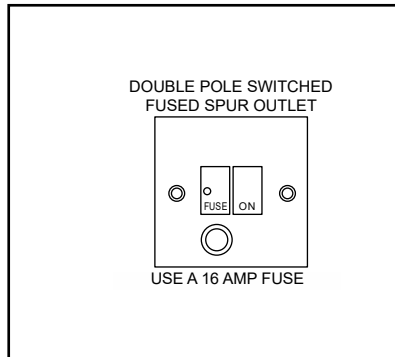

Direct Connection

If the appliance is being connected directly to the mains an omnipolar circuit-breaker must be installed with a minimum opening of 3mm between contacts.

If the cable is damaged or to be replaced, the operation must be carried out the by a qualified electrician with dedicated tools to avoid any accidents.

The installer must ensure that the correct electrical connection has been made and that it complies with wiring diagram.

The cable must not be bent or compressed.

The cable must be checked regularly and replaced by authorized technicians only.

Electrical Requirements

Any permanent electrical installation must comply with the latest I.E.E. Regulations and local electricity company regulations. For your own safety a qualified electrician or contractor who is on the roll of the National Inspection Council for Electrical Installation Contracting (NICEIC) should undertake the electrical installation.

Electrical Connection

Before connecting the mains supply ensure that the mains voltage corresponds to the voltage on the rating plate inside the appliance.

WARNING: THIS APPLIANCE MUST BE EARTHED

The appliance is supplied with a 3-core mains cable and must be connected to the electricity supply via a double pole switch having a 3mm minimum contact gap on each connector.

The wires in the mains lead are coloured in accordance with the following code:

Brown = L - Live

Blue = N - Neutral

Green/Yellow = ⊕ Earth

The connection point must be placed in a position adjacent to the appliance so as to be readily accessible for an engineer in the event of a breakdown.

Disconnect the appliance from the mains supply before carrying out any kind of maintenance or cleaning.

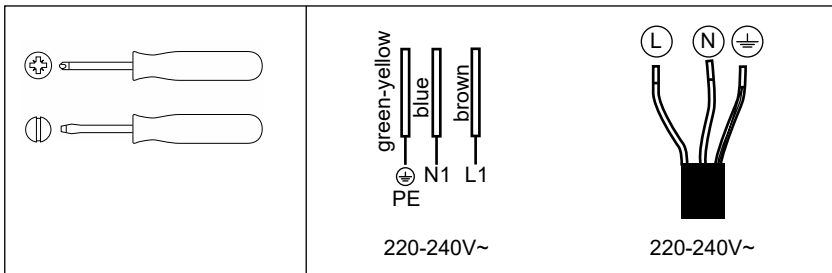

In more detail...

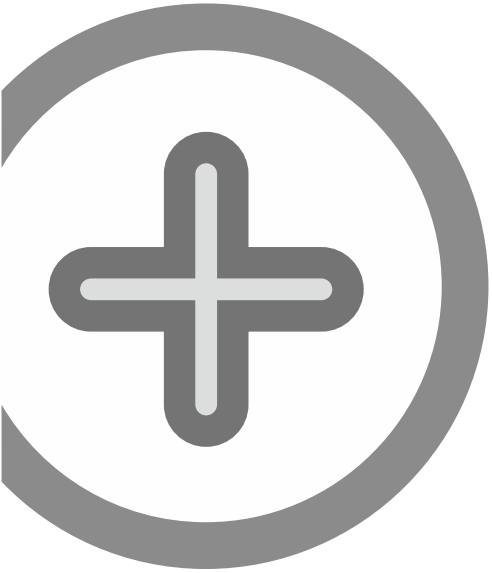

Appendix ...

Installation

Hob installation



Caution

The ceramic hob must be installed by a suitably qualified person. Never try to install the appliance yourself. The ceramic hob must not be installed above refrigerators, freezers, washing machines or tumble dryers. The wall and the area above the hob should be able to withstand heat.

- > Cut a hole in the worktop of the size shown in the diagram. The worktop should be at least 30 mm thick and made of a heat-resistant material. Seal cut edge of the worktop with silicone or PVA.

Electrical connection



Caution

- The cord should not be extended or folded into coil during operation.
- Adapters, multi-socket strips and extension leads must not be used.
- Overloading could result in a risk of fire.



Caution

Before connecting to the power supply, check:

- The voltage meets requirements.
- The appliance uses an individual socket and does not share one with another electric appliance. A dedicated power protection switch must be incorporated in the fixed wiring in accordance with the wiring rules.

Clearance

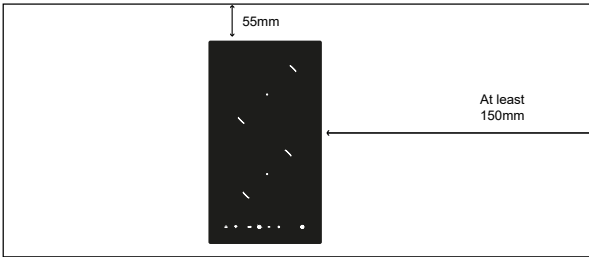

Technical Specification

Cooking zones	2 zones
Supply voltage	220-240V~
Total power	3000W (230V~)
Product size L×W×H (mm)	290×520×60
Build-in dimension A×B (mm)	260×490

Weight and Dimensions are approximate. Because we continually strive to improve our products we may change specifications and designs without prior notice.

Installation instructions

Remove all the packing materials plus disposal statement.

Siting (see fig.1)



Caution

Good ventilation is required around the appliance for easier dissipation of heat and low power consumption.

Sufficient clearance is required around the appliance.

The appliance should not be placed near anything that may echo.

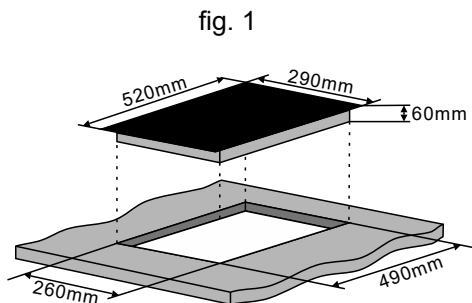
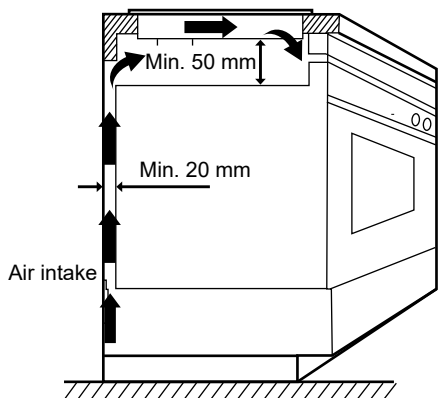

- > The ceramic hob must be well ventilated and the air inlet and outlet must not be blocked. Please select heat-resistant work surface material to avoid larger deformation caused by the heat radiation from the hotplate.
- > NOTE: The safety distance between the ceramic hob and the cupboard above the hotplate should be at least 750 mm.

fig. 2

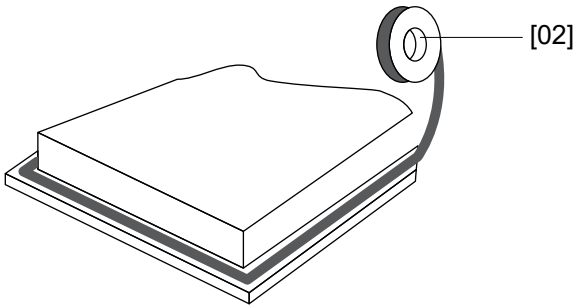

02



[04] x 1

Stretch out the supplied seal along the underside edge of the hob, ensuring the ends overlap.

03

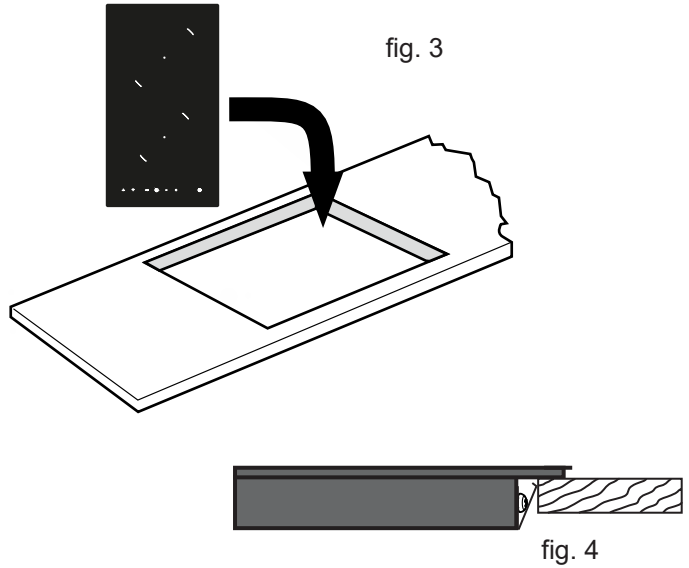

Do not use adhesive to fix the hob into the worktop.

Once the seal is fitted position the hob into the cutout in the worktop. Apply gentle downwards pressure onto the hob to push it into the worktop ensuring a good seal around the outer edge (fig. 4)

This appliance requires a 32 Amp Miniature Circuit Breaker.

We reserve the right for printing errors and omissions. This guide applies to several countries and therefore some functions and installation instructions cannot be used in your particular country.

