

Induction Hob

Instruction Manual / Installation Manual

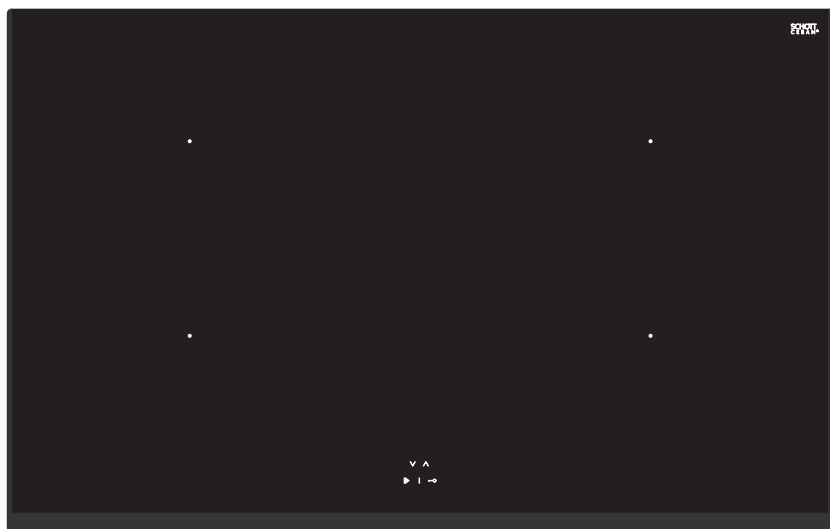

PEI3082



K110000536

Safety Warnings

Your safety is important to us. Please read this information before using your cooktop.

- ✓ The appliance is not to be used by persons (including children) with reduced physical, sensory or mental capabilities, or lack of experience and knowledge, unless they have been given supervision or instruction. children being supervised not to play with the appliance.
- ✓ Warning: If the surface is cracked, switch off the appliance to avoid the possibility of electric shock, for hob surfaces of glass-ceramic or similar material which protect live parts.
- ✓ Warning: a steam cleaner is not be used.
- ✓ Metallic objects such as knives, forks, spoons and lids should not be placed on the hob surface since they can get hot.
- ✓ After use, switch off the hob element by its control and do not rely on the pan detector.
- ✓ That the appliance is not intended to be operated by means of external timer or separated remote-control system.
- ✓ Danger of fire: Do not store items on the cooking surfaces.

- ✓ CAUTION: The cooking process has to be supervised. A short term cooking process has to be supervised continuously.
- ✓ WARNING: Unattended cooking on a hob with fat or oil can be dangerous and may result in a fire.
- ✓ If the supply cord is damaged, it must be replaced by the manufacturer, its service agent or similarly qualified persons in order to avoid a hazard.
- ✓ This appliance can be used by children aged from 8 years and above and persons with reduced physical, sensory or mental capabilities or lack of experience and knowledge if they have been given supervision or instruction concerning use of the appliance in a safe way and understand the hazards involved. children shall not play with the appliance. cleaning and user maintenance shall not be made by children without supervision.
- ✓ WARNING: The appliance and its accessible parts become hot during use.
- ✓ Care should be taken to avoid touching heating elements.
- ✓ Children less than 8 years of age shall be kept away unless continuously supervised.

- ✓ **WARNING:** Unattended cooking on a hob with fat or oil can be dangerous and may result in fire.
- ✓ **NEVER** try to extinguish a fire with water, but switch off the appliance and then cover flame e.g. with a lid or a fire blanket.
- ✓ **CAUTION:** The cooking process has to be supervised. A short term cooking process has to be supervised continuously.
- ✓ **WARNING:** Danger of fire: do not store items on the cooking surfaces.
- ✓ **WARNING:** Use only hob guards designed by the manufacturer of the cooking appliance or indicated by the manufacturer of the appliance in the instructions for use as suitable or hob guards incorporated in the appliance. The use of inappropriate guards can cause accidents.
- ✓ Power cord can't accessible after installation.

Congratulations on the purchase of your new Induction Hob.

We recommend that you spend some time to read this Instruction / Installation Manual in order to fully understand how to install correctly and operate it.





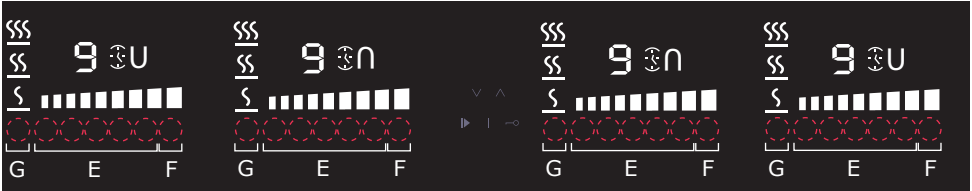

For installation, please read the installation section.

Read all the safety instructions carefully before use and keep this Instruction / Installation Manual for future reference.

Product Overview

User interface



Reference	Description
A 	ON/OFF key
B 	Child lock key
C 	Pause key
D 	Timer control keys
E Power slider regulating keys	
	Power slider regulating indicator 
F Boost control key	
	Boost control indicator 
G Cooking functions key	
	Cooking function indicator 

Heating Zone Power

Heating Zone	PEI3082 Total Power (220-240V~ 50/60Hz)
Front left zone	2000/3100W (Booster)
Rear left zone	1500/2500W (Booster)
Rear Right zone	1500/2500W (Booster)
Front Right zone	2000/3100W (Booster)
Total Rating Power	7400W (230 V~)

About induction cooking

Induction cooking is a safe, advanced, efficient, and economical cooking technology. It works by electromagnetic vibrations generating heat directly in the pan, rather than indirectly through heating the glass surface. The glass becomes hot only because the pan eventually warms it up.

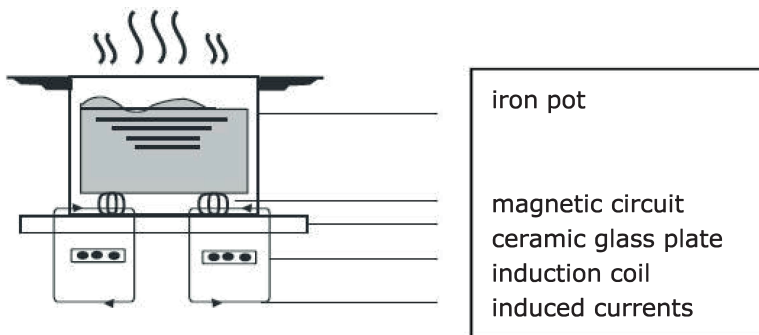

Before using your hob

- Read this guide, taking special note of the 'Safety Warnings' section.
- Remove any protective film that may still be on your Induction hob.

Using the touch controls

- The controls respond to touch, so you don't need to apply any pressure.
- Use the ball of your finger, not its tip.
- You will hear a beep each time a touch is registered.
- Make sure the controls are always clean, dry, and that there is no object (e.g. a utensil or a cloth) covering them. Even a thin film of water may make the controls difficult to operate.



Choosing the right Cookware



- Only use cookware with a base suitable for induction cooking. Look for the induction symbol on the packaging or on the bottom of the pan.
- You can check whether your cookware is suitable by carrying out a magnet test. Move a magnet towards the base of the pan. If it is attracted, the pan is suitable for induction.
- If you do not have a magnet:
 1. Put some water in the pan you want to check.
 2. If **L** does not flash in the display and the water is heating, the pan is suitable.
- Cookware made from the following materials is not suitable: pure stainless steel, aluminum or copper without a magnetic base, glass, wood, porcelain, ceramic, and earthenware.



Do not use cookware with jagged edges or a curved base.



Make sure that the base of your pan is smooth, sits flat against the glass, and is the same size as the cooking zone. Use pans whose diameter is as large as the graphic of the zone selected. Using a pot a slightly wider energy will be used at its maximum efficiency. If you use smaller pot efficiency could be less than expected. Pot less than 140 mm could be undetected by the hob. Always centre your pan on the cooking zone.

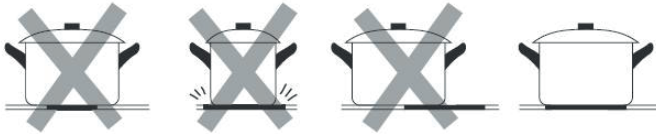

Always lift pans off the Induction hob – do not slide, or they may scratch the glass.

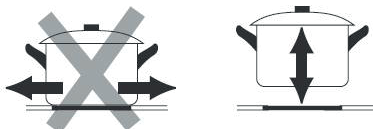

Special functions

Over-Temperature Protection

A temperature sensor equipped can monitor the temperature inside the Induction hob. When an excessive temperature is monitored, the Induction hob will stop operation automatically.

Detection of Small Articles

When an unsuitable size or non-magnetic pan (e.g. aluminium), or some other small item (e.g. knife, fork, key) has been left on the hob, the hob automatically go on to standby in 1 minute. The fan will keep cooking down the induction hob for a further 1 minute.

Auto Shutdown Protection

Auto shut down is a safety protection function for your induction hob. It shut down automatically if ever you forget to turn off your cooking. The default working times for various power levels are shown in the below table: .

Power level	1~3	4~6	7~8	9
Default working timer (min)	360	180	120	90

When the pot is removed, the induction hob can stop heating immediately and the hob automatically switch off after 2 minute.



People with a heart pace maker should consult with their doctor before using this unit.

Using your Induction Hob

To start cooking

1. Touch the ON/OFF key (A) for 3 secnds.
After power on, the buzzer beeps once, all displays show " - ", indicating that the induction hob has entered the state of standby mode.



2. Place a suitable pan on the cooking zone that you wish to use.
 - Make sure the bottom of the pan and the surface of the cooking zone are clean and dry.

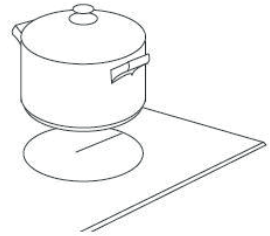

3. According to the heating zone where the pan is placed, adjust heat setting by touching the slider regulating key(E) control.

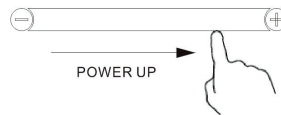

- If you don't choose a heat setting within 20 seconds, the induction hob will automatically switch off. You will need to start again at step 1.
- You can modify the heat setting at any time during cooking.

If the display flashes alternately with the heat setting

This means that:

- you have not placed a pan on the correct cooking zone or,
- the pan you're using is not suitable for induction cooking or,

- the pan is too small or not properly centred on the cooking zone.
No heating takes place unless there is a suitable pan on the cooking zone.
The display will automatically turn off after 1 minutes if no suitable pan is placed on it.

When you have finished cooking

1. Touching the slider regulating key(E) to decrease the power to "0" level.
2. Beware of hot surfaces
"H" will show which cooking zone is hot to touch. It will disappear when the surface has cooled down to a safe temperature. It can also be used as an energy saving function if you want to heat further pans, use the hotplate that is still hot.

Using the Boost function

Activated the boost function

Touching the relevant zone boost control key(F)  ,the zone indicator show "P." and the power reach Max.

Cancel the Boost function

Touching the slider regulating key(E) to cancel the Boost function, then the cooking zone will revert to the power level you wish.

- The function can work in any cooking zone.
- The cooking zone returns to level 9 after 2 minutes automatic.

Using Cooking Functions

You can choose 3 handy cooking functions by pressing the cooking functions key(G)  each time moves from one function to the other.



-Melt or defrost (about 50°C)



-Heating or keeping warm (about 70°C)



-Simmering , temperature close to boiling ,useful for slow cooking

FLEXIBLE AREA

- This area can be used as a single zone, accordingly to the cooking needs anytime.
- Flexible area is made of two independent inductors that can be controlled separately. When working as a single zone, a cookware is moved from one zone to the other one within the flexible area keeping the same power level of the zone where the cookware originally was placed, and the part that is not covered by cookware is automatically switched off.
- **Important:** Make sure to place the cookwares centered on the single cooking zone. The ideal recipe is an oval or rectangular saucepan, or a saucepan. Examples of good pot placement and bad pot placement.

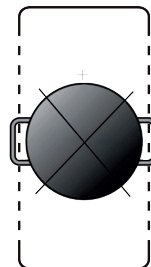
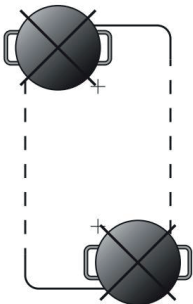
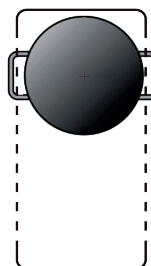
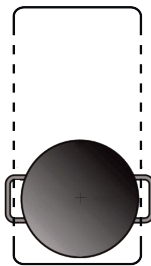
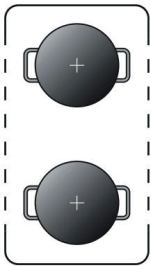

1. To activate the flexible area as a single big zone, simply press the **same time related heating zone power slider regulating key at least 2 second**

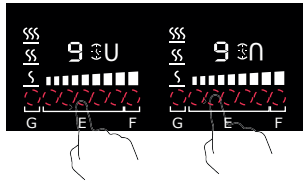

2. The flexible zone indicator **U&n** next to the power lever indicator will be light up.



3. According to the heating zone where the pan is placed, adjust heat setting by touching the front left zone or the front right zone slider regulating key(E) control.

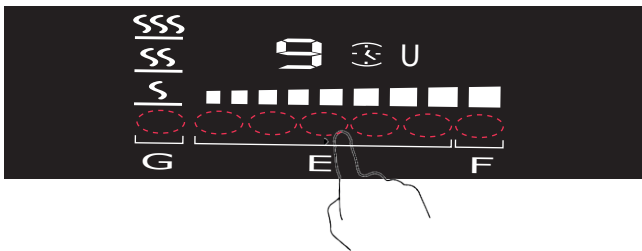

4. If the pot is moved from the front to the rear part (or viceversa),the flexible area detects automatically the new position, keeping the same power.

Using Child Lock Function

- You can lock the controls to prevent unintended use (for example children accidentally turning the cooking zones on).
- When the controls are locked, all the controls except the OFF control are disabled.

To lock the controls

Touch the child lock key  for 3 seconds. The indicator above the child lock key will be on and the timer indicator will show "Lo "

To unlock the controls

2. Touch and hold the keylock control for a while
3. You can now start using your Induction hob.



When the hob is in the lock mode, all the controls are disable except OFF , you can always turn the hob off with the OFF control in an emergency, but you shall unlock the hob first in the next operation .

Using the Timer



You can use the timer in two different ways:

- You can use it as a minute minder. In this case, the timer will not turn any cooking zone off when the set time is up.
- You can set it to turn one cooking zone off after the set time is up.
- You can set the timer for up to 99 minutes.

Using the Timer as an alarm

1. After selecting the cooking zone and the power level required, the dot next to power level indicator will flash for 5 seconds.



2. When the dot stops flashing, touch the timer control key(D)  or  , you can realize the setting of timing from 1 to 99 minutes.

Hint: Touch the "∨" or "∧" control of the timer once to decrease or increase by 1 minute. Touch and hold the "∨" or "∧" control of the timer to decrease or increase by 10 minutes.

3. When the time is set, it will begin to count down immediately. The display will show the remaining time, and the dot next to timer indicator will keep on flashing.



88.8

4. Buzzer will bips and the timer indicator will turn off when the setting time finished.

Setting the timer to switch off zones

1. Selecting the relevant cooking zone by touching the power slider regulating key to set the power lever you required, the dot next to power level indicator will flash for 5 seconds.
2. Before the dot stops flashing, touch the timer control key(D) ^ or ∨ , you can realize the setting of timing from 1 to 99 minutes.

Hint: Touch the "-" or "+" control of the timer once will decrease or increase by 1 minute. Touch and hold the "-" or "+" control of the timer will decrease or increase by 10 minutes.

3. When the time is set, it will begin to count down immediately. The timer setting indicator will show the remaining time and the timer indicator  will flash for 5 seconds.
4. After that, if the indicator  will keep on flashing meaning that the timer setting indicator shows the relevant zone remaining time until the timer expires; or else the indicator  will keep on lighting until the timer expires.

5. When cooking timer expires, the corresponding cooking zone will be switch off automatically. Other cooking zone will keep operating if they are turned on previously.
4. When using "the timer as an alarm" and "the timer to switch off the zones " together ,the timer setting indicator will show the remaining time of alarm as first priority. Press power slider regulating key(E) of relevant cooking zone to show the remaining time of switch off timer.

Using the pause function

The hob have a handy restart function to pause and restart the cooking process if you're interrupted.

1. When the hob is on and working, press the pause key(C) ► , all burner will stop working,and all LED indicator will show the symbol "=" .
2. press the pause key(C) ► again, all setting will restart at the previous setting.

Failure display and inspection

If an abnormality comes up, the induction hob will enter the protective state automatically and display corresponding protective codes:

Error Message	Possible Cause	What to do
	No pot or pot not suitable;	Replace the pot;
ER03	Water or pot on the glass over the control	Clean the user interface
F1 E	The connection between the display board and the left mainboard is fail (the cooking zone which indicator showing "E")	1.Connection cable not correctly plugged or defective; 2.Replace the Mainboard.
F3 E	Coil temperature sensor failure. (the cooking zone which indicator showing "E")	Replace the coil sensor
F4 E	Mainboard temperature sensor failure. (the cooking zone which indicator showing "E")	Replace the mainboard
E1 E	Temperature sensor of the ceramic glass plate is high	Please restart after the induction hob cools down.
E2 E	Temperature sensor of the IGBT is high	Please restart after the induction hob cools down.
E3 E	Abnormal supply voltage(too high)	Please inspect whether power supply is normal; Power on after the power supply is normal.
E4 E	Abnormal supply voltage (too low)	Please inspect whether power supply is normal; Power on after the power supply is normal.
E5 E	Temperature sensor failure(the cooking zone which indicator showing "E")	Connection cable not correctly plugged or assemble defective;

The above are the judgment and inspection of common failures.

Please do not disassemble the unit by yourself to avoid any dangers and damages to the induction hob and **please contact the supplier.**

Installation

Cut out the work surface according to the sizes shown in the drawing. For the purpose of installation and use, a minimum of 5 cm space shall be preserved around the hole.

Be sure the thickness of the work surface is at least 30 mm. Please select heat-resistant work surface material to avoid larger deformation caused by the heat radiation from the hotplate. As shown below:

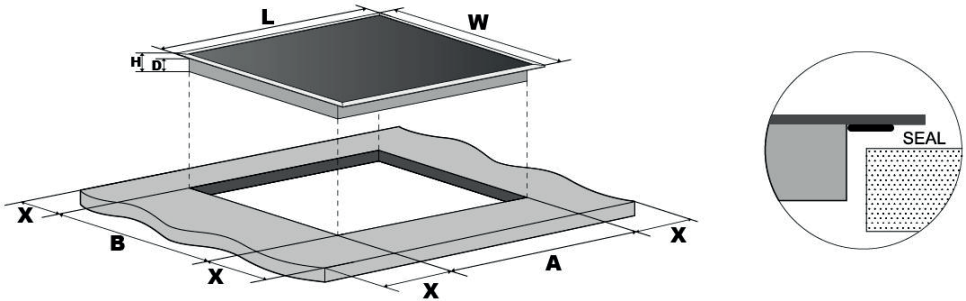

L(mm)	W(mm)	H(mm)	D(mm)	A(mm)	B(mm)	X(mm)
820	520	53	49	750	490	50 mini

Under any circumstances, make sure the Induction cooker hob is well ventilated and the air inlet and outlet are not blocked. Ensure the induction cooker hob is in good work state. As shown below

A (mm)	B (mm)	C
50 mini	20 mini	Air intake

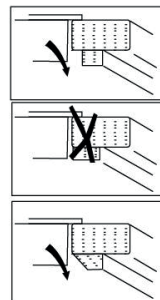
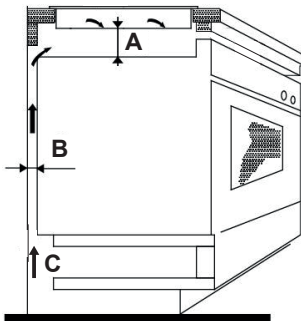

Before you install the hob, make sure that

- the work surface is square and level, and no structural members interfere with space requirements
- the work surface is made of a heat-resistant material
- if the hob is installed above an oven, the oven has a built-in cooling fan
- the installation will comply with all clearance requirements and applicable standards and regulations
- a suitable isolating switch providing full disconnection from the mains power supply is incorporated in the permanent wiring, mounted and positioned to comply with the local wiring rules and regulations.

The isolating switch must be of an approved type and provide a 3 mm air gap contact separation in all poles (or in all active [phase] conductors if the local wiring rules allow for this variation of the requirements)

- the isolating switch will be easily accessible to the customer with the hob installed
- you consult local building authorities and by-laws if in doubt regarding installation
- you use heat-resistant and easy-to-clean finishes (such as ceramic tiles) for the wall surfaces surrounding the hob.

When you have installed the hob, make sure that

- the power supply cable is not accessible through cupboard doors or drawers
- there is adequate flow of fresh air from outside the cabinetry to the base of the hob
- if the hob is installed above a drawer or cupboard space, a thermal protection barrier is installed below the base of the hob to avoid touching the bottom of the hob.
- the isolating switch is easily accessible by the customer

Installation of the product

fig. 1

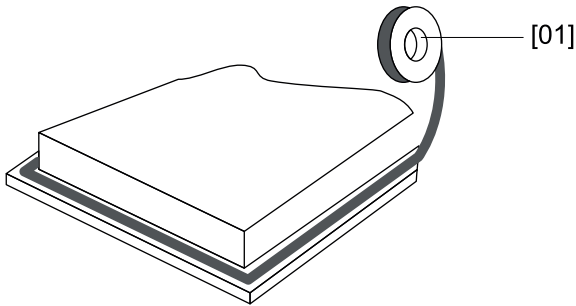

01



[04] x1

Stretch out the supplied seal along the underside edge of the hob, ensuring the ends overlap.

02

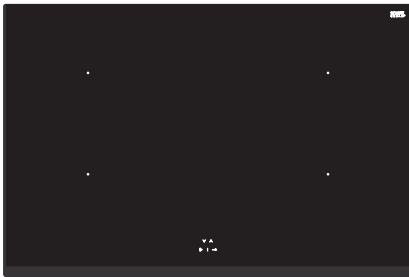

fig.2

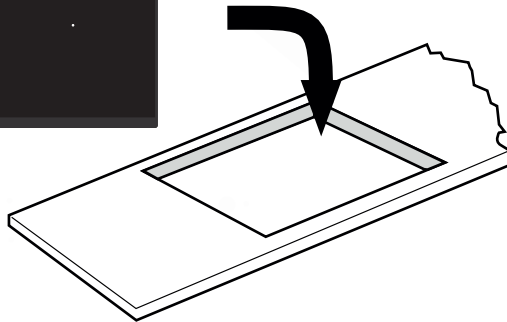

fig.3

Do not use adhesive to fix the hob into the worktop.

Once the seal is fitted position the hob into the cutout in the worktop. Apply gentle downwards pressure onto the hob to push it into the worktop ensuring a good seal around the outer edge (fig. 3)

Cautions

1. The induction hotplate must be installed by qualified personnel or technicians.
We have professionals at your service. Please never conduct the operation by yourself.
2. The hob will not be installed directly above a dishwasher, fridge, freezer, washing machine or clothes dryer, as the humidity may damage the hob electronics
3. The induction hotplate shall be installed such that better heat radiation can be ensured to enhance its reliability.
4. The wall and induced heating zone above the table surface shall withstand heat.
5. To avoid any damage, the sandwich layer and adhesive must be resistant to heat.

Connecting the hob to the mains power supply



This hob must be connected to the mains power supply only by a suitably qualified person. Before connecting the hob to the mains power supply, check that:

1. the domestic wiring system is suitable for the power drawn by the hob.
 2. the voltage corresponds to the value given in the rating plate
 3. the power supply cable sections can withstand the load specified on the rating plate.
- To connect the hob to the mains power supply, do not use adapters, reducers, or branching devices, as they can cause overheating and fire.

The power supply cable must not touch any hot parts and must be positioned so that its temperature will not exceed 75°C at any point.



Check with an electrician whether the domestic wiring system is suitable without alterations. Any alterations must only be made by a qualified electrician.

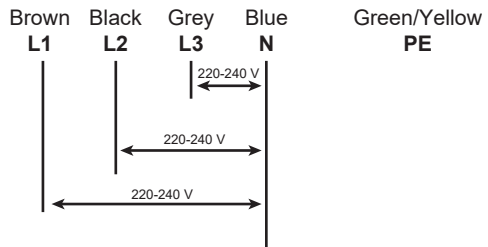
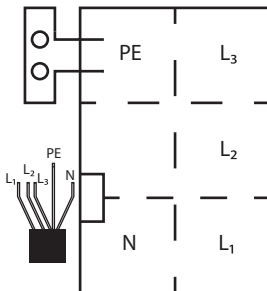

- If the cable is damaged or to be replaced, the operation must be carried out the by after-sale agent with dedicated tools to avoid any accidents.
- If the appliance is being connected directly to the mains an omnipolar circuit-breaker must be installed with a minimum opening of 3mm between contacts.
- The installer must ensure that the correct electrical connection has been made and that it is compliant with safety regulations.
- The cable must not be bent or compressed.
- The cable must be checked regularly and replaced by authorised technicians only.

This appliance requires a 32 Amp Miniature Circuit Breaker.



DISPOSAL: Do not dispose this product as unsorted municipal waste. Collection of such waste separately for special treatment is necessary.

This appliance is labeled in compliance with European directive 2011/65/EU for Waste Electrical and Electronic Equipment (WEEE). By ensuring that this appliance is disposed of correctly, you will help prevent any possible damage to the environment and to human health, which might otherwise be caused if it were disposed of in the wrong way.

The symbol on the product indicates that it may not be treated as normal household waste. It should be taken to a collection point for the recycling of electrical and electronic goods.

This appliance requires specialist waste disposal. For further information regarding the treatment, recover and recycling of this product please contact your local council, your household waste disposal service, or the shop where you purchased it.

For more detailed information about treatment, recovery and recycling of this product, please contact your local city office, your household waste disposal service or the shop where you purchased the product.

We reserve the right for printing errors and omissions. This guide applies to several countries and therefore some functions and installation instructions cannot be used in your particular country.

